

Technical Specification

Kohler PW 8000DPA



Pioneering solutions for
total power protection

Kohler PW 8000DPA UPS SYSTEM DESCRIPTION

Using a unique modular construction, the Kohler PW 8000DPA model range represents a completely new generation of medium power 3-phase UPS systems that incorporate the latest technological developments in power engineering. High reliability, upgrade ability, low operating costs and excellent electrical performance are just some of the highlights of this innovative UPS solution. The system's advanced double conversion, Voltage and Frequency Independent (VFI) topology fully satisfies the highest availability and environmentally-friendly requirements compliant with the most stringent safety, EMC and other important UPS standards. It is certified to International Standard ISO 9001/EN 29001 and ISO 14001.

The Kohler PW 8000DPA is a truly modular system based on 10kVA or 20kVA UPS modules. Depending on the model, the system can contain up to ten 10kVA or 20kVA UPS modules connected in parallel and configured to operate as either a redundant (n+1) or increased capacity system. Two model ranges are available.

Kohler PW 8000DPA-ST model range

In the Kohler PW 8000DPA-ST model range the UPS modules are located in a purpose designed cabinet, along with the power switch panel, power connectors and a range of communication I/O facilities. The ST cabinet-mounted system is rated according to the maximum number of 20kVA modules that can be housed – i.e. 40kVA, 60kVA, 80kVA, 120kVA and 200kVA. ST-40 (40kVA) and ST-60 (60kVA) cabinets are designed to contain the UPS batteries but in the case of ST80 (80kVA), ST-120 (120kVA) and ST-200 (200kVA) systems the batteries must be housed externally, usually in a matching cabinet positioned adjacent to the UPS cabinet. Note that where a system contains internal batteries an additional battery cabinet can also be connected to the system to increase the available autonomy time.

Kohler PW 8000DPA-RI model range

In the Kohler PW 8000DPA-RI system the UPS modules are housed in a 19 inch sub-rack assembly along with the power switch panel, power connectors and a range of communication I/O facilities. The sub-rack can include a number of shelves to house the batteries and several designs are available to offer range of UPS Module and battery combinations.

The Kohler PW 8000DPA-RI model number indicates the number of UPS module housings and battery shelves contained in a particular sub-rack assembly. The first number relates to the number of UPS module housings and the second refers to the number of battery shelves – for example the RI-12 has facilities for 1 UPS module and 2 battery shelves, whereas the RI-22 contains 2 UPS module housings and 2 battery shelves. The Kohler PW 8000DPA-RI model range extends from RI-10 (10kVA/20kVA) up to RI-40 (40/80kVA). Note that the 80kVA model does not contain battery shelves.

System expansion

Thanks to the advanced Kohler PW 8000DPA system design, if a cabinet/rack is not fully populated it is possible to add further UPS Modules, as required, to increase the system capacity without having to power-down the system or in any way disrupt the load. For example if an RI-40 (four-module) system is initially purchased with only two UPS Modules fitted an additional two modules may be fitted at a later date. This 'hot-swappable' design also means that individual modules can be exchanged while the equipment is running without the need to transfer the load to the bypass supply (depending on the system redundancy and existing load demand). Note that all the UPS Modules fitted within a cabinet/sub-rack must be of the same rating – i.e. it is not possible to mix 10kVA and 20kVA UPS Modules in the same parallel system.

This Technical Specification provides detailed information concerning the mechanical, electrical and environmental performance of the Kohler PW 8000DPA intended to support and give answers to tender and end-user requirements.

KEY FEATURES	
Best-in-class efficiency	<i>95.5% efficiency across a wide load range</i>
Compact size, small foot print	<i>Integral batteries (up to 60kVA), saving on expensive floor space</i>
Easy to replace hot-swappable UPS modules	<i>Replace or add modules with no down-time Simple and cost effective upgrading</i>
Flexible battery management	<i>Advanced management of battery charging and preventive failure diagnostics avoids premature deterioration of battery life.</i>
Blade-server-friendly power; full power from 0.9 lead to 0.8 lag	<i>No de-rating required with leading PF loads</i>
Ergonomic design	<i>Easy serviceability</i>
Eco friendly	<i>Energy saving and low carbon footprint</i>
Low power factor at partial and full load (p.f.>0.99 @100% load)	<i>Cost savings during installation and the entire life cycle (TCO)</i>

GENERAL SPECIFICATIONS

Mechanical Characteristics (Kohler PW 8000DPA-RI Models)

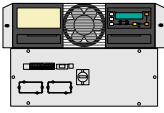
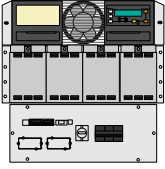
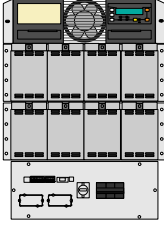
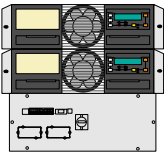
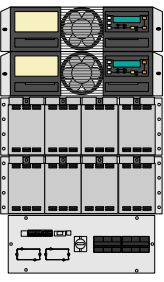
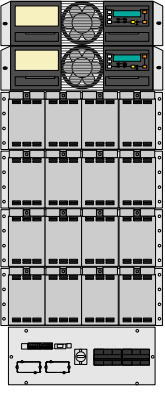
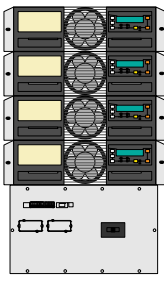
RI Rack-mounted Models		RI-10	RI-11	RI-12	RI-20
					
Configuration: (10 or 20kVA modules)	Max .	1 module and External batteries	1 module and 40 x 7/9Ah batteries	1 module and 80 x 7/9Ah batteries	2 modules and External batteries
Max. Power connection	kW	20	20	20	40
Dimensions (WxHxD)	mm	448x310x565 (7 HU)	448x487x735 (11 HU)	448x665x735 (15 HU)	448x440x565 (10 HU)
Weight of empty frame	kg	20	40	56	25
Weight of frame with modules and w/o batteries	kg	39 up to 42 (with 1 Modules)	59 up to 62 (with 1 Module)	75 up to 78 (with 1 Module)	44 up to 47 (with 2 Modules)
		RI-22	RI-24	RI-40	
					
Configuration: (10 or 20kVA modules)	Max .	2 modules and 80 x 7/9Ah batteries	2 modules and 160 x 7/9Ah batteries	4 modules and External batteries	
Max. Power connection	kW	40	40	80	
Dimensions (WxHxD)	mm	448x798x735 (18 HU)	448x1153x735 (26 HU)	448x798x735 (18 HU)	
Weight of empty frame	kg	66	93	50	
Weight of frame with modules and w/o batteries	kg	104 up to 110 (with 2 Modules)	131 up to 137 (with 2 Modules)	124 up to 136 (with 4 Modules)	

Mechanical Characteristics (Kohler PW 8000DPA-ST Models)

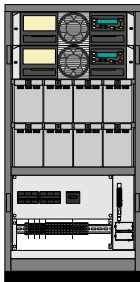
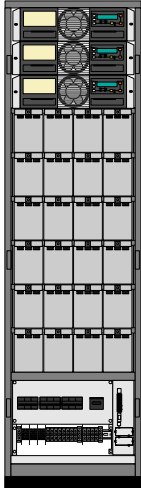
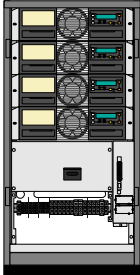
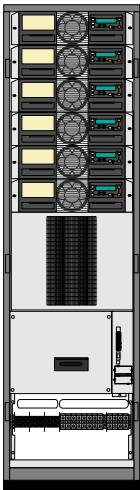
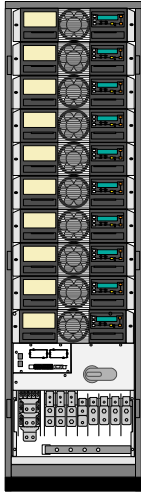
ST Cabinet-mounted Models		ST-40	ST-60	ST-80
				
Configuration: (10 or 20kVA modules)	Max.	2 modules and 80 x 7/9Ah batteries	3 modules and 240 x 7/9Ah batteries	4 modules and NO batteries
Max. Power connection	kW	40	60	80
Dimensions (WxHxD)	mm	550x1135x770	550x1975x770	550x1135x770
Weight of Empty Cabinet	kg	92	173	82
Weight of Cabinet with modules and w/o batteries	kg	130 up to 136 (with 2 Modules)	229 up to 238 (with 3 Modules)	157 up to 169 (with 4 Modules)
		ST-120	ST-200	
				
Configuration: (10 or 20kVA modules)	Max.	6 modules and NO batteries	10 modules and NO batteries	
Max. Power connection	kW	120	200	
Dimensions (WxHxD)	mm	550x1975x770	550x1975x770	
Weight of Empty Cabinet	kg	133	174	
Weight of Cabinet with modules and w/o batteries	kg	245 up to 263 (with 6 Modules)	360 up to 389 (with 10 Modules)	
Colours		Front: Graphite grey (Pulverlacke No. 4222903402 serie 09RCCAT1) Side walls: Graphite grey (Pulverlacke No. 4222903402 serie 09RCCAT1)		

UPS Module Characteristics

Mechanical Characteristics (UPS Modules)		10kVA UPS Module	20kVA UPS Module
Output Active Rated Power	KW	10	20
Variable Number of 12V Battery Blocks	No.	24-50 *	36-50 *
Dimensions (WxHxD)	mm	488 x 132 x 540 (3 HU)	
Weight UPS Module	kg	18.6	21.5
Colours		Front: RAL 7016	
*Depending of the effective load in kW used by the module			

Heat Dissipation Per Module With Non-Linear Load		10kVA UPS Module	20kVA UPS Module
Heat dissipation with 100% non-linear load per module (EN 62040-1-1:2003)	W	550	1100
	BTU/h	1887	3745
Airflow (25° - 30°C) with non-linear load per module (EN 62040-1-1:2003)	m³/h	150	150
Dissipation at no load	W	120	150

Input Characteristics		10kVA UPS Module	20kVA UPS Module
Output Rated Power per Module $\cos\phi$ 0.8	kVA	10	20
Output Rated Power per Module $\cos\phi$ 1.0	KW	10	20
Nominal Input Voltage	V	3x380/220V+N, 3x400V/230V+N, 3x415/240V+N	
Input Voltage Tolerance (ref to 3x400/230V) for Loads in %:	V	(-23%/+15%) 3x308/177 V to 3x460/264 V for <100% load (-30%/+15%) 3x280/161 V to 3x460/264 V for < 80% load (-40%/+15%) 3x240/138 V to 3x460/264 V for < 60% load	
Input Frequency	Hz	35 – 70	
Input Power Factor		PF=0.99 @ 100% load	
Inrush Current	A	max. In	
Input Distortion THDI		Sine-wave THDi = 3% @ 100% load	
Max. Input Power with rated output power and charged battery per Module (output $\cos\phi$ = 1.0)	kW	10.5	21
Max. Input Current with rated output power and charged battery per Module (output $\cos\phi$ = 1.0)	A	15.2	30.4
Max. Input Power with rated output power and discharged battery per Module (output $\cos\phi$ = 1.0)	kW	11.5	23
Max. Input Current with rated output power and discharged battery per Module (output $\cos\phi$ = 1.0)	A	16.6	33.3

Battery Characteristics		10kVA UPS Module	20kVA UPS Module
Variable Number of 12V Battery Blocks	No.	24-50 *	36-50 *
Maximum Battery Charger Current	A	4 A	4 A
Battery Charging Curve		Ripple free: IU (DIN 41773)	
Temperature compensation		Temperature sensor (optional)	
Battery Test		Automatic and periodically (adjustable)	
Battery Type		Maintenance free VRLA or NiCd	
* Depending of the effective load in kW used by the module			

Battery Capacity Usage	10kVA UPS Module				20kVA UPS Module			
Number of battery blocks	24	28	30	34-50	36	40	40	48-50
Max. Power in KW	8	8	10	10	16	20	16	20
Max. autonomy (min.)	5	999	5	999	5	5	999	999

Output Characteristics		10kVA UPS Module	20kVA UPS Module
Output Rated Power per Module Cosφ 0.8	kVA	10	20
Output Rated Power per Module Cosφ 1.0	KW	10	20
Output Current In @ Cosφ 1.0 (400 V)	A	14.5	29
Output Rated Voltage	V	3x380/220V or 3x400/230V or 3x415/240V	
Output Voltage Stability	%	Static: < +/- 1% Dynamic (Step load 0%-100% or 100%-0%)< +/- 4%	
Output Voltage Distortion	%	With Linear Load< 1.5% With Non-linear Load (EN62040-3:2001)< 3%	
Output Frequency	Hz	50 Hz or 60 Hz	
Output Frequency Tolerance	%	Synchronized with mains < +/- 2% (selectable for bypass operation) or < +/- 4% Free running +/- 0.1%	
Bypass operation		At Nominal Input voltage of 3x400 V +/- 15% or 190 V to 264 V ph-N	
Permissible Unbalanced Load (All 3 phases regulated independently)	%	100%	
Phase Angle Tolerance (With 100% Unbalanced load)	Deg.	+/- 0 deg.	
Overload Capability on Inverter	%	125% load for 10 min. 150% load for 60 secs.	
Output short capability (RMS)	A	Inverter: 3 x In during 40 ms Bypass: 10 x In during 20 ms	
Crest - Factor		3: 1	

Communication Options	
Power Management Display (PMD)	1 x LCD display for each module
RJ45 Plug (Not used) [JR2]	RJ45 Plug (for future options)
Customer Interfaces: Inputs DRY PORT [X1]	1 x Remote Shut-down [EMERGENCY OFF (normally closed)] 2 x Programmable Customer Inputs <ul style="list-style-type: none"> • 1st. default as GEN-ON (normally open) • 2nd. free (normally open) 1 x Temperature sensor for battery control 1 x 12Vdc output (max 200mA)
Customer Interfaces: Outputs DRY PORT [X2]	5 Voltage free contacts For remote signalling and automatic computer shutdown
Serial ports RS232 on Sub-D9 [JD1]	1 x system frame For monitoring integration in network management and service
USB	1x For monitoring and software management
Slot for SNMP [SLOT 2]	SNMP card (optional) For monitoring and integration in network management
Slot for PowerREPORTER [SLOT 1]	PowerREPORTER card (optional) for Premium Power Protection

Environmental Characteristics		10kVA UPS Module	20kVA UPS Module
Audible Noise with 100% / 50% Load	dBA	55 / 49	57 / 49
Operation temperature	°C	0 – 40	
Ambient Temperature for Batteries (recommended)	°C	20	
Storage Temperature	°C	-25 - +70	
Battery Storage Time at Ambient Temperature		Max. 6 months	
Max. altitude (above sea level)	m	1000m (3300ft) without de-rating	
De-rating factor for use at altitudes above 1000m sea level according (IEC 62040-3)		Height above sea level (m / ft)	De-Rating Factor for Power
		1500 / 4850	0.95
		2000 / 6600	0.91
		2500 / 8250	0.86
		3000 / 9900	0.82
Relative Air-humidity		Max. 95% (non-condensing)	
Accessibility		Totally front accessibility for service and maintenance (no need for side, top or rear access)	
Positioning		ST Models: min. 200mm rear space (300mm for ST200 model) required for ventilation RI Models: 900mm required for cabling	
Input and Output Power Cabling		ST Models: From the bottom at the front RI Models: From the bottom at the rear	
Efficiency AC-AC up to (at Cosφ 1.0) (depending on Module power)	%	Load: 100% 75.0% 50.0% 25.0% 20kVA: 95.5% 95.5% 95.0% 94.5% 10kVA: 95.5% 95.5% 95.0% 94.5%	
Efficiency with Linear Load at cosφ =0.8 ind. Efficiency Non-linear Load (EN 62040-1-1:2003)		Typically up to 1% higher of above values Typically up to 1% lower of above values	
Eco-Mode efficiency at 100% load	%	98%	

Standards	10kVA UPS Module	20kVA UPS Module
Safety	EN 62040-1-1:2003, EN 60950-1:2001/A11:2004	
Electromagnetic Compatibility	EN 62040-2:2005, EN61000-3-2:2000, EN61000-3-3:1995/A1:2001, EN61000-6-2:2001	
Emission Class	C2	
Immunity Class	C3	
Performance	EN62040-3:2001	
Product certification	CE	
Degree of protection	IP 20	

COMMUNICATION OPTION DETAILS

Power Management Display (PMD)

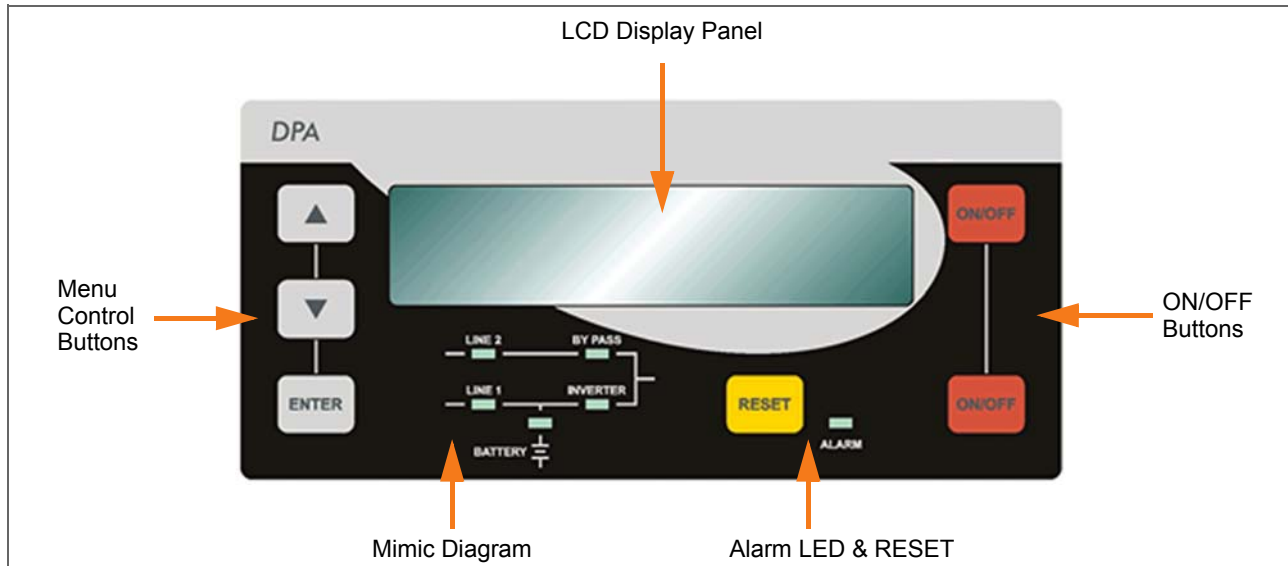

A user-friendly Power Management Display (PMD) provides access to all monitoring information and operator controls.

Mimic Diagram

The mimic diagram contains multi-coloured LEDs that change between Green, Red and Off to indicate the UPS operational power flow status.

LEDs LINE 1 and LINE 2 indicate the availability of the input mains and bypass mains power supplies respectively, and are both Green during normal operation.

The INVERTER and BYPASS LEDs indicate which of the two power sources is providing the critical load supply. These LEDs illuminate Green to indicate which is the active supply source.

The BATTERY LED indicator shows solid Green when the battery is being charged and flashes when the battery is discharging –e.g. when the battery is providing the load power during a mains failure.

The ALARM LED, located at the lower-centre area of the PMD, is a visual indication of any monitored internal or external alarm condition. When activated, it is accompanied by an audible alarm that can be cancelled using the RESET button.

LCD Display Panel

A 2 x 20 character multi-function LCD Display provides a simple communications interface that enables the operator to monitor important UPS operating parameters and alarm warnings. It also allows the operator to undertake various control operations such as transferring the load between the inverter and bypass. The display is menu-driven using the UP/DOWN and ENTER buttons.

LCD Display Panel summary:

- Displays the input and output voltage, current, frequency and power
- Displays an 'Event register' which stores a date/time stamped history of the 99 most recent alarms and events
- Enables battery run time monitoring
- Enables selection of commands such as UPS Start-up and Shut-down, Load transfer from inverter to bypass and vice-versa
- Provides diagnostic facilities (service mode only)
- In conjunction with the operator keys, provides UPS adjustments and testing facilities (service mode only)

ON/OFF Control Buttons

The PMD has two ON/OFF control buttons which must be pressed simultaneously in order to turn ON or OFF the UPS. These buttons are duplicated to reduce the likelihood of inadvertent operation.

JD1 Smart Port – Serial RS 232 and USB Port

JD1 is a standard D-Type, 9-pin, female socket, and the USB is a standard USB port.

The SMART PORT is an intelligent RS 232 serial port that allows the UPS to be connected to a computer. When used in conjunction with the optional SMART PORT software, WAVEMON, it enables the computer to continuously monitor the mains voltage and UPS-status, and display messages in the event of any UPS system changes.

Customer Input Interfaces (Terminal block X1)

All the customer input interfaces are connected to terminal block X1 by means of Phoenix terminals (cable 0.5 mm²)

Terminal block X1 allows the customer to connect optional external UPS control inputs as shown in the table below..

Terminal	Contact	Signal	Function
X1/1	IN ← ○	+12Vdc	Customer IN 1 (default as ONGENERATOR operation) (NC = Generator ON)
X1/2	GND ● ○	Gnd	
X1/3	IN ← ○	+12Vdc	Customer IN 2 (Function on request, to be defined on purchase)
X1/4	GND ● ○	Gnd	
X1/5	IN ← ○	+3.3Vdc	Battery Temperature If connected, the battery charger current is temperature dependent
X1/6	GND ● ○	Gnd	
X1/7	IN ← ○	+12Vdc	Remote shutdown Do not remove the factory mounted bridge until an external remote shut down is connected
X1/8	GND ● ○	Gnd	
X1/9	OUT ○ →	+12Vdc	12Vdc source Max 200mA load
X1/10	GND ● ○	Gnd	

Customer Output Interfaces (Terminal block X2) (DRY PORTS)

The switched outputs shown in the table below are provided to allow integration with a customer's building management facilities; for example, to provide an automatic and orderly shutdown of servers, AS400 or other automated systems.

All the outputs shown are voltage free contacts rated at 60 VAC max. and 500 mA.

Pin	Contact	Signal	Function	
X2/1		Alarm	MAINS_OK	Mains Present
X2/2				Mains Failure
X2/3				Common
X2/4		Message	LOAD_ON_INV	Load On Inverter
X2/5				(Load on bypass)
X2/6				Common

Pin	Contact	Signal		Function
X2/7	NO ● ○	Alarm	BATT_LOW	Battery Low
X2/8	NC ● ○			Battery OK
X2/9	Com ●			Common
X2/10	NO ● ○	Message	LOAD_ON_MAINS	Load On Mains (BYPASS-MODE)
X2/11	NC ● ○			(Load on Inverter)
X2/12	Com ●			Common
X2/13	NO ● ○	Alarm	COMMON_ALARM	Common Alarm
X2/14	NC ● ○			No Alarm Condition
X2/15	Com ●			Common

SNMP card/adaptor for network management/remote monitoring

Simple Network Management Protocol (SNMP) is a world-wide, standardised communication protocol that can be used to monitor any network-connected device via a simple control language and display the results in an application running within a standard web browser.

The Kohler PW 8000DPA contains two SNMP slots; one is designed to house a Modem/Ethernet SNMP adapter card and the other a Modem/GSM adapter. Alternatively, SNMP connectivity can also be implemented using an external SNMP adapter connected to the UPS RS232 output (JD1).

An SNMP/Ethernet adapter contains an RJ-45 connector which allows it to be connected to the network using a standard network cable. Once connected, the UPS-Management software agent, which is already installed in the SNMP adapter, then monitors the UPS operating parameters. In a multi-module UPS system the SNMP interface can communicate 'system-wide' data or data for an individual UPS module.

The SNMP card enables automated event/alarm emails, server shutdown (with optional licenses) and other tasks. It card can also be integrated with BMS software over a local area network (LAN) for SNMP or Modbus information over IP. An optional card enables Modbus comms over RS485.

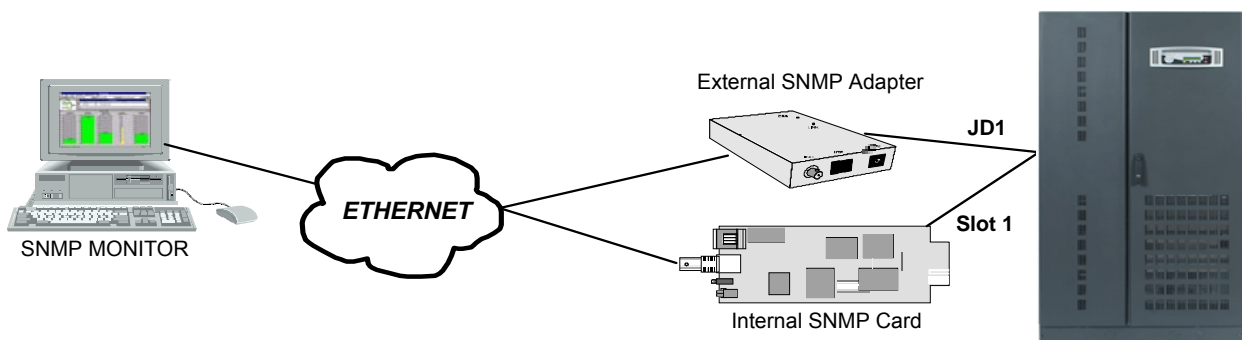

RCCMD Server shutdown

In order that remote shutdown of servers can take place, initiated by the SNMP card or WAVEMON software, further licenses must be purchased. The license is for the RCCMD client (or listening) software that resides in each target server.

INSTALLATION PLANNING

The following *guidelines* should be taken into account when planning a suitable UPS location and environment.

Location considerations summary

- The UPS equipment must be installed and transported in a upright position.
- The floor at the installed location and en-route from the off-loading point must be able to safely take the weight of the UPS and battery equipment.
- The floor material where the UPS is to be located should be non-flammable.
- Local fire protection standards must be respected.
- Ensure that appropriate power supplies are available and that UPS cabling can be performed easily.
- The location must be vibration free.
- If the UPS is to be installed in bayed enclosures, partition walls must be installed.

Environmental considerations summary

- Avoid high ambient temperature, moisture and humidity.
Humidity (< 90% non-condensing) and temperature (+15°C to +25°C) are within prescribed limits.
- An ambient temperature of 20°C is recommended to achieve a long battery life.
- Any prescribed air cooling flow must be available. Ensure the air conditioning system can provide a sufficient amount of air cooling to keep the room at, or below, the maximum desired temperature.
- Ensure no dust or corrosive/explosive gases are present.

CLEARANCES

The diagrams below illustrate the required clearances that must be provided around the UPS and external battery cabinet (where used). All parts of the UPS that require access for maintenance, servicing and user operation are accessible from the front of the rack. Ensure that all ventilation ports are kept free of obstruction.

RI (Rack mounted) models

RI models are mounted in a standard 448mm rack. A space of 1000mm should be provided at the front of the rack to allow maintenance access and 900mm should be provided at the rear of the rack to allow access to the UPS input and output power connections.

Min Clearance (mm)	X	Y
All Models	200	900

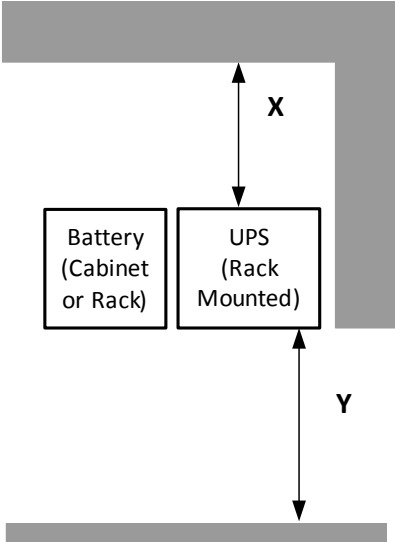

ST Models

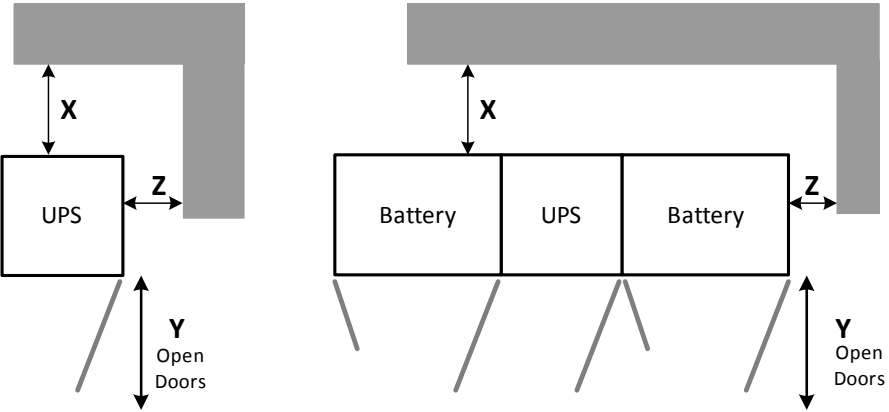

All service and main tenace can be carried out from the front of the UPS cabinet. Cables are connected from the bottom front of the cabinet. Battery cabinets are bespoke to the installation.

Min Clearance (mm)	X	Y	Z
ST-40/ST-80	200	900	50-100
ST-60/ST-120	200	900	50-100
ST-200	300	900	50-100

	ST-40	ST-60	ST-80	ST-120	ST-200
Footprint (WxHxD) mm	550 x 1135 x 770	550 x 1975 x 770	550 x 1135 x 770	550 x 1975 x 770	550 x 1975 x 770

UPS POWER CABLING

The UPS can be wired for a 'single feed' input (standard) whereby the UPS input supply terminals and bypass supply terminals are internally linked together; or a 'dual feed' input, where the UPS bypass terminals are connected to a dedicated 'bypass' mains supply.

All input and bypass (where used) cables should be connected through a LV-Distribution board and protected by a circuit breaker or fuse to provide overload protection and a means of isolating the UPS from the mains supply if required. Similarly, the UPS output cables should be connected to the load equipment via a suitably fused load distribution panel.



Key Point: It is the customer's responsibility to provide all the external fuses, isolators and cables used to connect the UPS input and output power supplies. The following diagrams identify the UPS input/output cabling requirements and provides information regarding the necessary fuse and cable ratings, and cable sizing.

Power connection terminals

All the UPS input/output power cables are connected to a row of terminal blocks mounted on a DIN rail located at the bottom of the UPS, except for the ST-200 model which uses busbars connections (shown opposite). For RI models the terminal rail is accessed from the rear of the UPS sub-rack but in the case of ST models it is accessed from the front of the UPS cabinet.

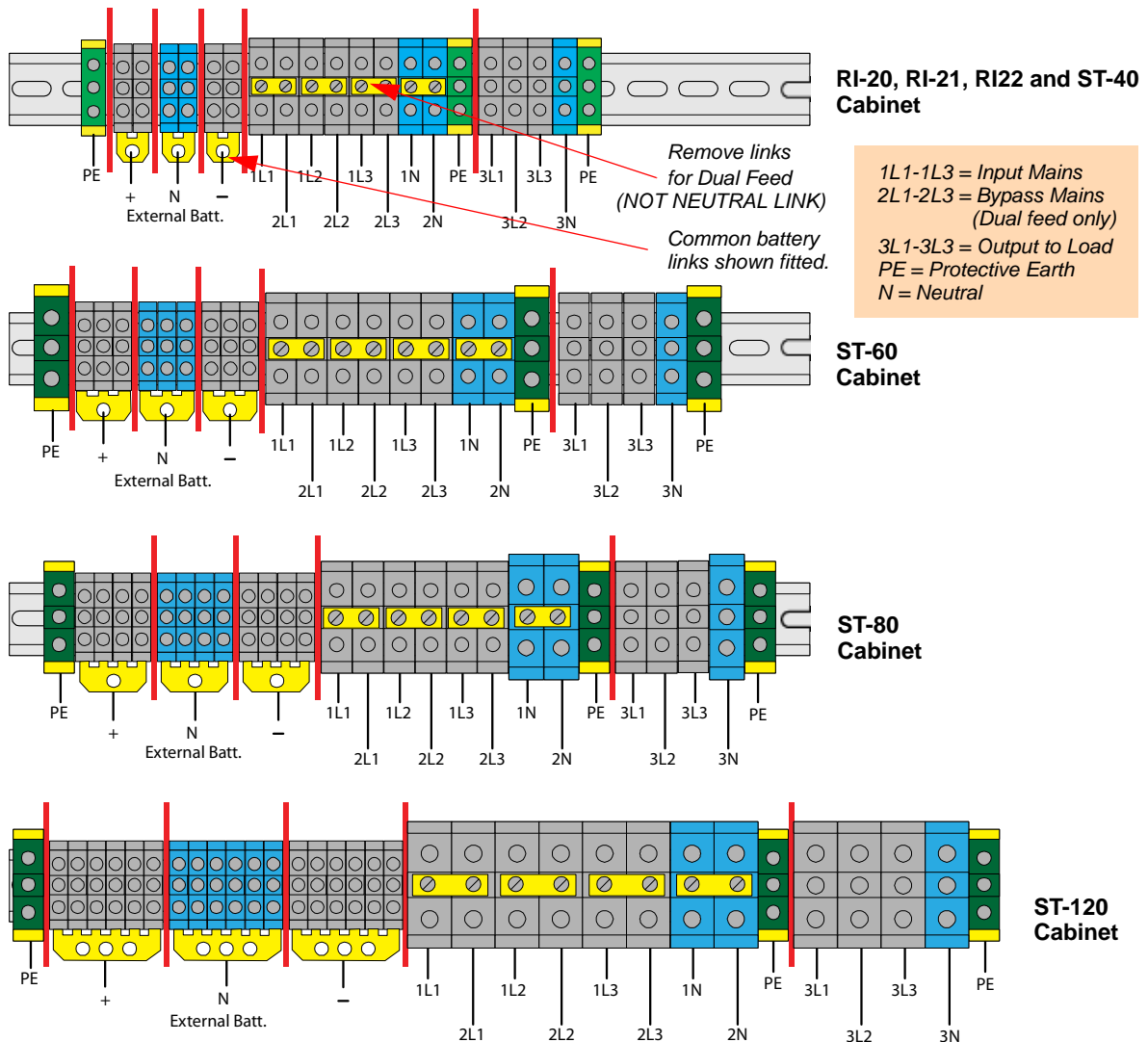

ST-200 Cabinet

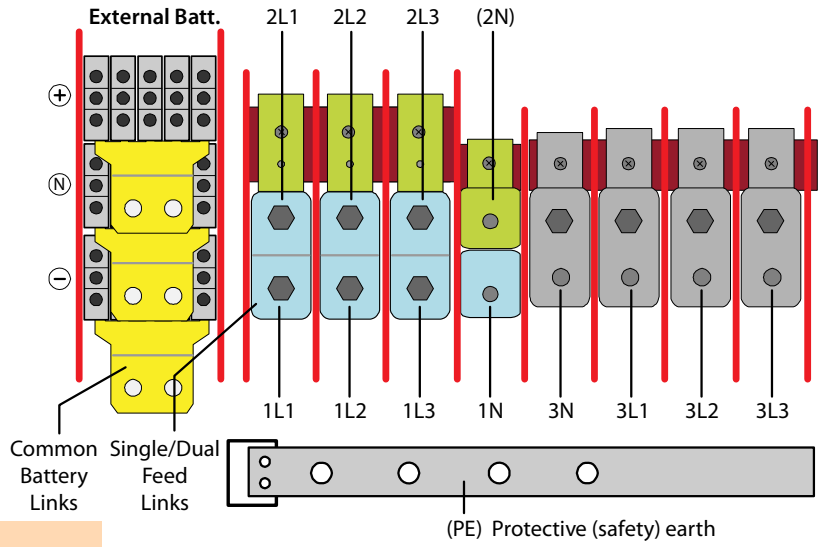

1L1-1L3 = Input Mains
2L1-2L3 = Bypass Mains (Dual feed only)
3L1-3L3 = Output to Load
PE = Protective Earth
N = Neutral

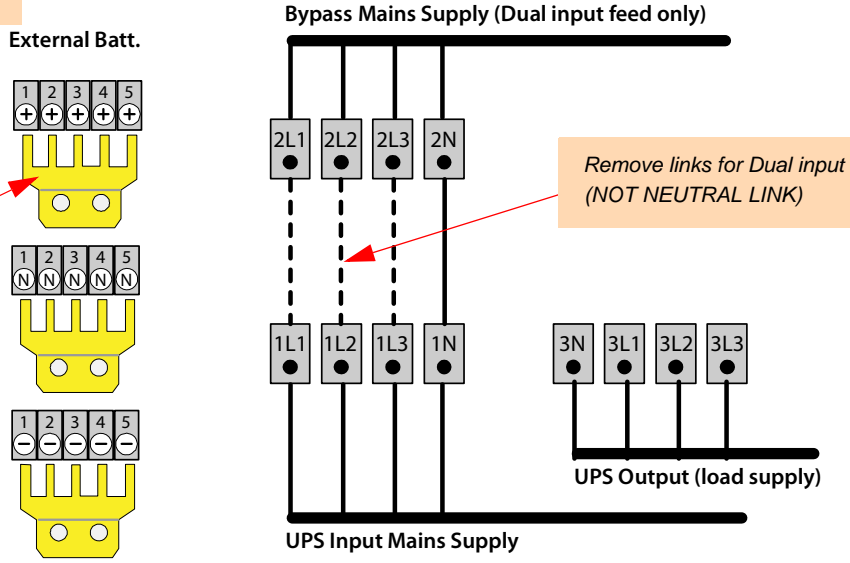

Single feed links

In a 'single feed' (standard) installation the input and bypass supply terminals are connected together by links fitted on the top of the terminal blocks, as shown in the upper illustration. These links must be removed if the UPS is to be used with a 'dual feed' supply. Note that the input/bypass Neutral link must be fitted in all cases.

Common battery links

If a 'common battery' configuration is used, all the UPS modules are connected to a common battery source comprising a number of parallel battery strings each of which is connected to the common battery links fitted to the bottom of the battery terminals.

Where an individual battery configuration is used, the common battery links are removed and the individual battery strings are connected to their respective UPS module's battery connections.

Terminal connection sizes

UPS Range	Battery Earth PE	Separate Battery (+ / N / -)	Common Battery (+ / N / -)
RI-10/11/12	16/25 mm ² (T)	3 x (10/16 mm ²) (T)	N/A
RI-20/22/24	16/25 mm ² (T)	2 x (3x10/16 mm ²) (T)	3x M5 (B)
RI-40	50 mm ² (T)	4 x (3x10/16 mm ²) (T)	3x M6 (B)
ST-40	16/25 mm ² (T)	2 x (3x10/16 mm ²) (T)	3x M5 (B)
ST-60	50 mm ² (T)	4 x (3x10/16 mm ²) (T)	3x M6 (B)
ST-80	50 mm ² (T)	4 x (3x10/16 mm ²) (T)	3x M6 (B)
ST-120	50 mm ² (T)	6 x (3x10/16 mm ²) (T)	3x (2 x M5) (B) or 3x M10 (B)
ST-200	1x M12 (B)	5 x 25 mm ² (T)*	3x (2 x M12) (B)

* In the ST-200 model each battery feeds two UPS modules in an individual battery configuration.

UPS Range	Input Bypass (2L1,2L2,2L3,2N)	Input Rectifier (1L1,1L2,1L3,1N,PE)	Output Load (3L1,3L2,3L3,3N, PE)
RI-10/11/12	4x 10/16 mm ² (T)	5x 10/16 mm ² (T)	5x 10/16 mm ² (T)
RI-20/22/24	4x 16/25 mm ² (T)	5x 16/25 mm ² (T)	5x 16/25 mm ² (T)
RI-40	3x 50 mm ² (T) + N 70/95 mm ² (T)	3x 50 mm ² (T) + N 70/95 mm ² (T) + PE 50 mm ² (T)	3x 50 mm ² (T) + N 70/95 mm ² (T) + PE 50 mm ² (T)
ST-40	4x 16/25 mm ² (T)	5x 16/25 mm ² (T)	5x 16/25 mm ² (T)
ST-60	4x 35 mm ² (T)	4x 35 mm ² (T) + PE 50 mm ² (T)	4x 35 mm ² (T) + PE 50 mm ² (T)
ST-80	4 x 50 mm ² (T) + N 70/95 mm ² (T)	3x 50 mm ² (T) + N 70/95 mm ² (T) + PE 50 mm ² (T)	3 x 50 mm ² (T) + N 70/95 mm ² (T) + PE 50 mm ² (T)
ST-120	4 x 70/95 mm ² (T)	4x 70/95 mm ² (T) + PE 50 mm ² (T)	4x 70/95 mm ² (T) + PE 50 mm ² (T)
ST-200	3x M12 (B) + PE 1x M12 (B)	4x M12 (B) + PE 1x M12 (B)	4x M12 (B) + PE 1x M12 (B)

Notes:

1. The UPS must be installed to prescribed IEC or local regulations.
2. Where external batteries are used, DC Cables and Battery fuses are bespoke to the installation.
3. (T) = screwed terminal block. Cable ends must be suitably prepared.
(B) = busbars. Cables must be fitted with suitable lugs to fit the indicated bolt size.

Fuses & Cables Quick Reference

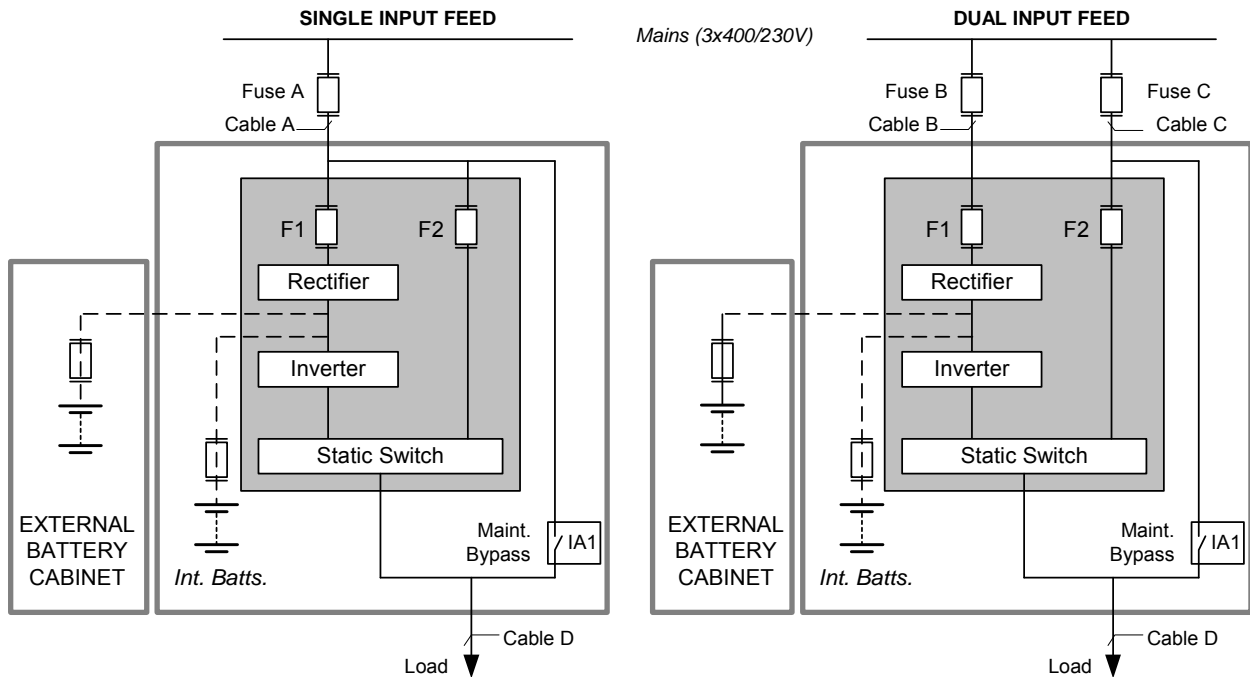

	Single Feed Input 3 x 400V/230V			Dual Feed Input 3 x 400V/230V					Output 3 x 400V/230V	
	Fuse A (Agl/CB)	Cable A (mm ²)	Max I/P Current	Fuse B (Agl/CB)	Cable B (mm ²)	Max I/P Current	Fuse C (Agl/CB)	Cable C (mm ²)	Cable D (mm ²)	I(nom)
RI-10/11/12	3x 40A	5x 6	27A	3x 40A	5x 6	27A	3x 40A	4x 6	5x 6	29A
RI-20/22/24	3x 80A	5x 16	68A	3x 80A	5x 16	68A	3x 80A	4x 16	5x 16	58A
RI-40	3x 160A	5x 50	136A	3x 160A	5x 50	136A	3x 160	4x 50	5x 50	116A
ST-40	3x 80A	5x 16	68A	3x 80A	5x 16	68A	3x 80A	4x 16	5x16	58A
ST-60	3x 125A	5x 35	102A	3x 125A	5x 35	102A	3x 125A	4x 35	5x 35	87A
ST-80	3x 160A	5x 50	136A	3x 160A	5x 50	136A	3x 160A	4x 50	5x 50	116A
ST-120	3x 250A	5x 95	208A	3x 250A	5x 95	208A	3x 250A	4x 95	5x 70	174A
ST-200	3x 350A	5x 185	333A	3x 350A	5x 185	333A	3x 350A	4x 185	5x 185	290A

Notes

1. Fuse and Cable recommendations to IEC 60950-1:2001 or locally recognised standard.
2. The fuse and cable rating details in the above tables are a recommendation only.
3. The UPS must be installed to prescribed IEC or local regulations.
4. Where external batteries are used, DC Cables and Battery fuses are bespoke to the installation.